

HP Series Smart Solar Charge Controller

User Manual

HP2410/HP2420/HP2420-S

1. Product Features

1. 12V/ 24 V system voltages are automatically recognized.
2. An upgraded 3-stage PWM charging algorithm is adopted. Application of an equalizing charging to the battery periodically or when over discharged, can effectively prevent the battery from non-equalization and sulfuration, thus extending the battery's service life.
3. With temperature compensation employed, charging parameters can be automatically adjusted.
4. A wide range of load working modes facilitate the product's application to different types of load.
5. The product provides overcharge, over-discharge, overload protection, as well as short-circuit protection.
6. By virtue of an advanced load starting method, large-capacitance loads can be started smoothly.
7. The product provides a dot matrix graphic LCD screen and a human-machine interface with a key.
8. The user-friendly design of browser and dynamic interfaces ensure convenient and intuitive operations.
9. Boasting an industrial grade design, the product can function well in various tough conditions.
10. TVS lightning protection is adopted.

2. Panel Structure

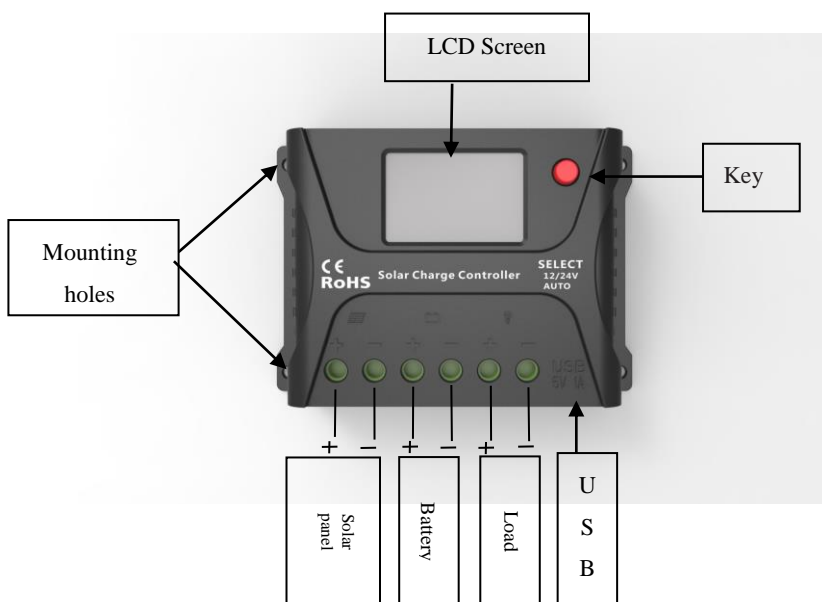

3. Installation Instructions and Precautions

1. The controller shall be installed securely, and its dimensions are as follows:
 - HP2410 External dimensions:103×71×36(mm)
 - Installation dimensions:96×60 (mm)
 - HP2420/HP2420-S External dimensions:130×75×38 (mm)
 - Installation dimensions:122×64(mm)
2. Installation hole diameter:3.5(mm)

HP Series Smart Solar Charge Controller User Manual HP2410/HP2420/HP2420-S

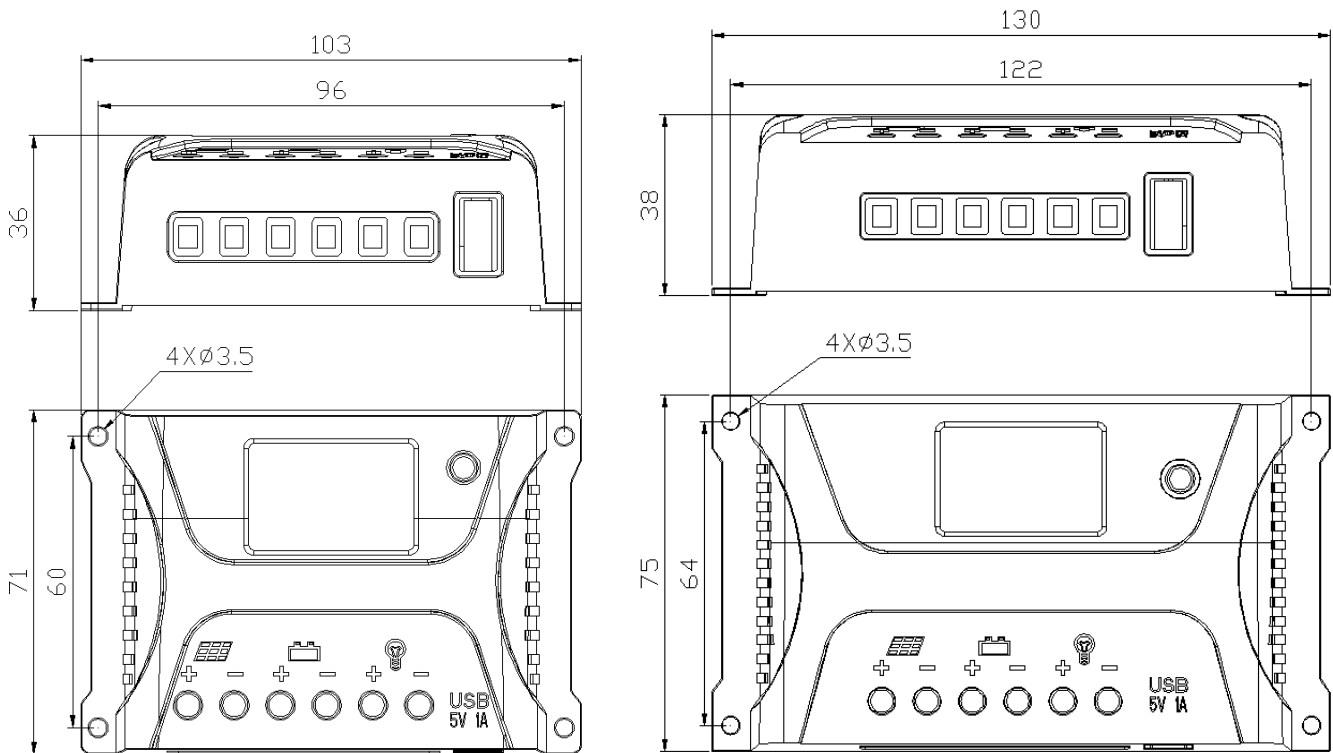

HP2410

HP2420/HP2420-S

3. Operation Instructions

- Step 1: Connect the battery. If the connection is correct, the controller screen lights up; otherwise, check whether the connection is correct.
- Step 2: Connect the solar panel. If sunlight is present and strong enough (the solar panel voltage is greater than battery voltage), the sun icon on the LCD screen is on; otherwise, check whether the connection is correct.
- Step 3: Connect the load. Connect the load leads to the controller's load output terminal, and the current shall not exceed the controller's rated current.

4. As the controller generates heat during operation, it is recommended that the controller be installed in an environment with good ventilation conditions.

5. Choose cables with large enough capacity for connection, in case too much loss incurred on the lines causes the controller to misjudge.

6. The controller has a common positive pole inside. If grounding is needed, ground the positive pole.

HP Series Smart Solar Charge Controller User Manual HP2410/HP2420/HP2420-S

7. It's important to fully charge the battery regularly. At least once full charging every month is recommended, and failure to do that may cause permanent damage to the battery. Only when in-flow energy outpaces out-flow energy can the battery be charged fully. Users shall bear this in mind when configuring the system.
8. Check whether the controller's each connection terminal is tightened securely; if not, it may suffer damage when there is excessive current.

4. Technical Data Sheet

Model	HP2410	HP2420	HP2420-S
Rated current	10A	20A	20A
current display function	No	No	Yes
System voltage	Automatic recognition of 12 V/ 24 V		
No-load loss	< 10mA/12V; < 12mA/24V		
Max. Solar energy input voltage	<55V		
Max. voltage at the battery end	<35V		
Overvoltage protection	17.0V; ×2/24V;		
Equalizing charging voltage	14.6V; ×2/24V;		
Boost charging voltage	14.4V; ×2/24V;		
Floating charging voltage	13.8V; ×2/24V;		
Charging recovery voltage	13.2V; ×2/24V;		
Over-discharge recovery voltage	12.6V; ×2/24V;		
Over-discharge voltage	11.1V; ×2/24V;		
Equalizing charging interval	30days		
Equalizing charging time	1H		
Boost charging time	2H		

HP Series Smart Solar Charge Controller User Manual HP2410/HP2420/HP2420-S

Temperature compensation	-3.0mV/°C/2V	
Light control voltage	Light control on 5V, ×2/24V; light control off 6V, ×2/24V;	
Light control judgment time	1 minute	
Operating temperature	-25°C to +55°C;	
IP protection degree	IP30	
Net weight	100g	160g
Protection functions	Solar panel short circuit and reverse-connection protection	
	Over-temperature, overload and short circuit protection	
Dimensions	103×71×36(m m)	130×75×38 (mm)

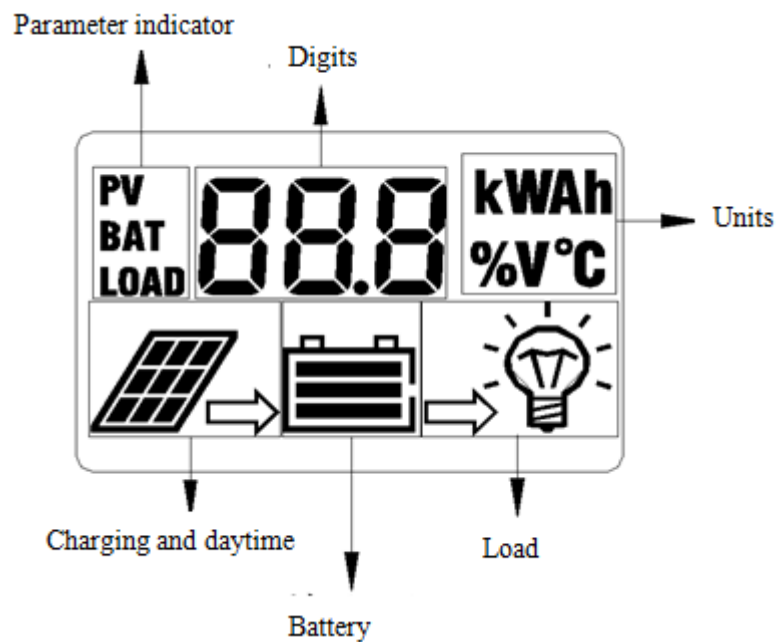

5. LCD Screen Illustration



6. State Indicators

LCD Icon	Indicated Object	State	Remark
PV	Solar panel data	Steady on	This data only for HP2420-S

HP Series Smart Solar Charge Controller User Manual HP2410/HP2420/HP2420-S

BAT	Battery data	Steady on	
LOAD	Load discharge data	Steady on	
	Daytime charging or	Steady on	
	Night recognition	Steady off	
	Load short circuit or overload	Quick flashing	
	Load switched on	Steady on	
	Load switched off	Steady off	
	Normal battery	All on	
	Over discharge	Only the outline flashes	
	Overvoltage	3 dashes flashing	

7. Browsing Menu on LCD Screen

The following menus are shown in an automatic cycle on the screen, with an interval of 3s.

- The figure 1 is for the model HP2410 and HP2420.

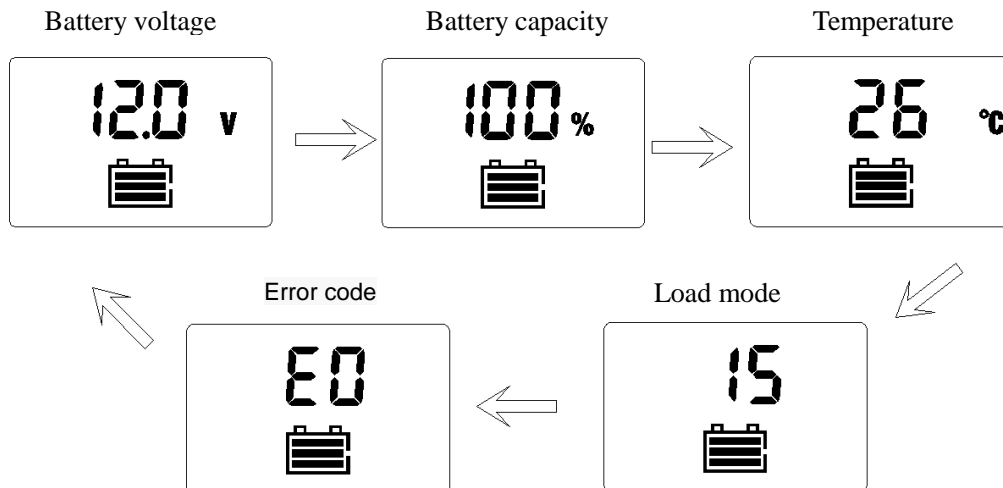

- The figure 2 is for the model HP2420-S.(Adding charging and discharging current display).

HP Series Smart Solar Charge Controller User Manual HP2410/HP2420/HP2420-S

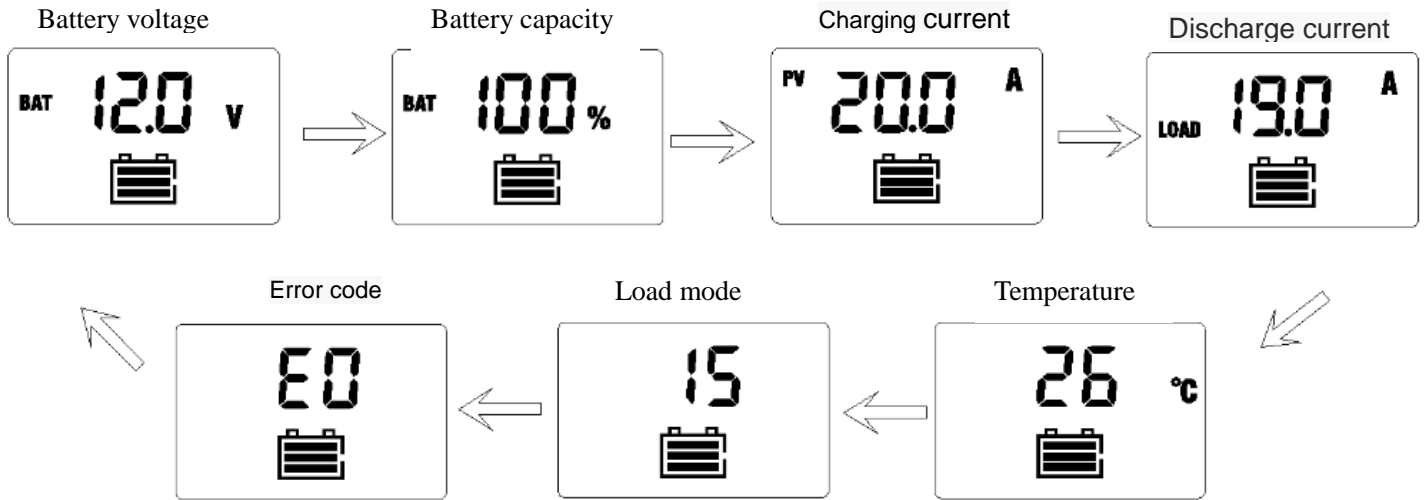

8. Setting Menu on LCD Screen

Long press the key in any mode to enter the load mode setting interface, and the load mode begins to flash. Short press the key to adjust the load mode, and long press the key again to save and exit mode setting or wait for 10s to let the system save and exit automatically.

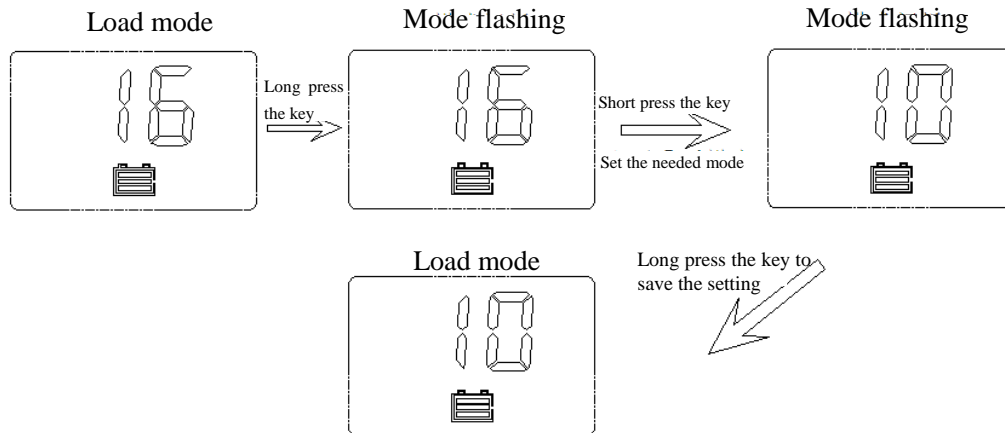

9. Five load Working Modes

1. Pure light control (0): When sunlight disappears and the light intensity drops to the starting point, the controller initiates a one minute delay (settable) to confirm the starting signal, and then switches on the load for operation. When sunlight emerges and the light intensity reaches the starting point, the controller initiates a **one minute** delay to confirm the shutting-down signal, and then shuts down the output to stop the load's operation.

HP Series Smart Solar Charge Controller User Manual HP2410/HP2420/HP2420-S

2. Light control + time control (1 to 14): The starting process is the same as pure light control. After operating for a preset period of time (settable from 1 to 14 hours), the load stops operation automatically.

3. Manual mode (15): In this mode, the user can switch the load on or off by the key, no matter whether it's day or night.

4. Debugging mode (16): In cases of 6V with light signals, the load will be shut off. In cases of 5V (varies according to the preset light controlled voltage and system voltage) without light signals, the load will be switched on. This mode enables fast check of the correctness of system installation during installation and debugging.

5. Normal on (17): The energized load keeps in output state.

LED Display	Mode
00	Pure light control mode
01-14	Light control + time control (1 to 14 hours)
15	Manual mode (default)
16	Debugging mode
17	Normal on mode

10. Manually Switching On/Off Load

When the load mode is set to 15 (manual mode), short press the key (non-setting mode) in any interface to switch on or off the load.

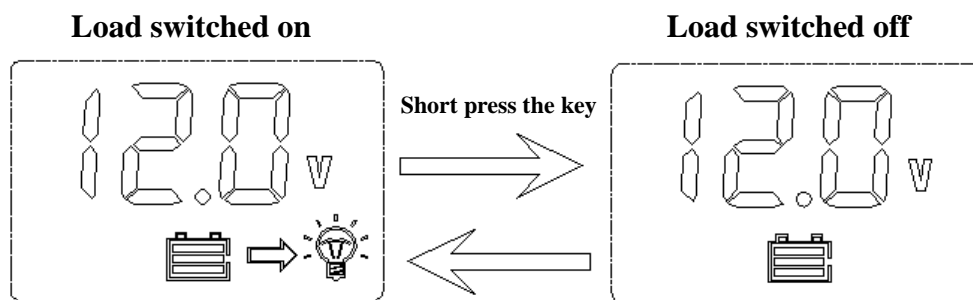

Note: As load start is a type of soft start, display of the load icon on the LCD screen will be delayed after the load is switched on.

11. Overload and Short Circuit Recovery

Overload and short circuit automatic recovery time: 5s at the 1st time; 10s at the 2nd time; 25s at the 3rd time; 30s at the 4th time; 30s at the 5th time, or automatic recovery the next day.

12. Error Code List

HP Series Smart Solar Charge Controller User Manual HP2410/HP2420/HP2420-S

Code on LCD screen	Corresponding error
E0	No error
E1	battery over-discharging
E2	battery overvoltage
E4	Load short circuit
E5	Overload
E6	Controller inner temperature over heat

13. Common Problems and Solutions

Symptoms	Causes and Solutions
LCD screen does not light up.	Check whether the battery is correctly connected.
Incomplete display or no renewal on LCD screen	Check whether the ambient temperature is too low and whether the display recovers when the temperature rises.
No charging with sunlight present	Check whether the solar panel is correctly connected, and contact is good and reliable. Check whether the solar panel voltage falls below the battery voltage.
The battery icon flashes quickly, and there is no output.	System overvoltage. Check whether the battery voltage is too high.
The battery icon flashes slowly, and there is no output.	The battery is over-discharged, and will recover after recharged adequately.
The load icon flashes quickly, and there is no output.	The load's power exceeds the rated value or the load is short-circuited. After the problem is solved, long press the key or wait until it recovers automatically.
Other symptoms	Check whether wiring is sound and reliable, and system voltage is correctly recognized.

The content of this manual is subject to change without prior notice.